

DAC101S101/DAC101S101Q

10-Bit Micro Power, RRO Digital-to-Analog Converter

General Description

The DAC101S101 is a full-featured, general purpose 10-bit voltage-output digital-to-analog converter (DAC) that can operate from a single +2.7V to 5.5V supply and consumes just 175 μ A of current at 3.6 Volts. The on-chip output amplifier allows rail-to-rail output swing and the three wire serial interface operates at clock rates up to 30 MHz over the specified supply voltage range and is compatible with standard SPI™, QSPI, MICROWIRE and DSP interfaces. Competitive devices are limited to 20 MHz clock rates at supply voltages in the 2.7V to 3.6V range.

The supply voltage for the DAC101S101 serves as its voltage reference, providing the widest possible output dynamic range. A power-on reset circuit ensures that the DAC output powers up to zero volts and remains there until there is a valid write to the device. A power-down feature reduces power consumption to less than a microWatt.

The low power consumption and small packages of the DAC101S101 make it an excellent choice for use in battery operated equipment.

The DAC101S101 is a direct replacement for the AD5310 and is one of a family of pin compatible DACs, including the 8-bit DAC081S101 and the 12-bit DAC121S101. The DAC101S101 operates over the extended industrial temperature range of -40°C to $+105^{\circ}\text{C}$ while the DAC101S101Q operates over the Grade 1 automotive temperature range of -40°C to $+125^{\circ}\text{C}$. The DAC101S101 is available in a 6-lead TSOT and an 8-lead MSOP and the DAC101S101Q is available in the 6-lead TSOT only.

Features

- DAC101S101Q is AEC-Q100 Grade 1 qualified and is manufactured on an Automotive Grade Flow.
- Guaranteed Monotonicity
- Low Power Operation
- Rail-to-Rail Voltage Output
- Power-on Reset to Zero Volts Output
- Wide Temperature Range of -40°C to $+125^{\circ}\text{C}$
- Wide Power Supply Range of +2.7V to +5.5V
- Small Packages
- Power Down Feature

Key Specifications

- | | |
|------------------------|---|
| ■ Resolution | 10 bits |
| ■ DNL | +0.15, -0.05 LSB (typ) |
| ■ Output Settling Time | 8 μ s (typ) |
| ■ Zero Code Error | 3.3 mV (typ) |
| ■ Full-Scale Error | -0.06 %FS (typ) |
| ■ Power Consumption | |
| ■ — Normal Mode | 0.63 mW (3.6V) / 1.41 mW (5.5V) typ |
| ■ — Pwr Down Mode | 0.14 μ W (3.6V) / 0.33 μ W (5.5V) typ |

Applications

- Battery-Powered Instruments
- Digital Gain and Offset Adjustment
- Programmable Voltage & Current Sources
- Programmable Attenuators
- Automotive

Pin Configuration

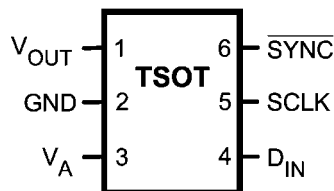

20154101

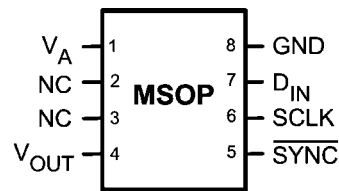

20154102

Ordering Information

Order Numbers	Temperature Range	Package	Top Mark	Feature
DAC101S101C1MM	$-40^{\circ}\text{C} \leq T_A \leq +105^{\circ}\text{C}$	MSOP	X62C	
DAC101S101C1MMX	$-40^{\circ}\text{C} \leq T_A \leq +105^{\circ}\text{C}$	MSOP T/R		
DAC101S101C1MK	$-40^{\circ}\text{C} \leq T_A \leq +105^{\circ}\text{C}$	TSOT	X63C	
DAC101S101C1MKX	$-40^{\circ}\text{C} \leq T_A \leq +105^{\circ}\text{C}$	TSOT T/R		
DAC101S101QCMK	$-40^{\circ}\text{C} \leq T_A \leq +125^{\circ}\text{C}$	TSOT	Q63C	AEC-Q100 Grade 1 Qualified; Automotive Grade Production Flow
DAC101S101QCMKX	$-40^{\circ}\text{C} \leq T_A \leq +125^{\circ}\text{C}$	TSOT T/R		
DAC101S101EVAL	Evaluation Board	TSOT		

Block Diagram

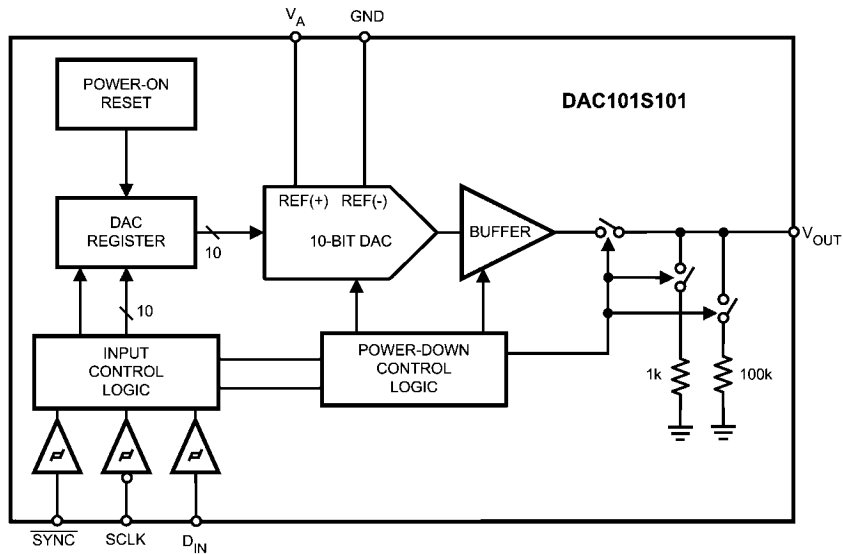

20154103

Pin Descriptions

TSOT (SOT-23) Pin No.	MSOP Pin No.	Symbol	Description
1	4	V_{OUT}	DAC Analog Output Voltage.
2	8	GND	Ground reference for all on-chip circuitry.
3	1	V_A	Power supply and Reference input. Should be decoupled to GND.
4	7	D_{IN}	Serial Data Input. Data is clocked into the 16-bit shift register on the falling edges of SCLK after the fall of \overline{SYNC} .
5	6	SCLK	Serial Clock Input. Data is clocked into the input shift register on the falling edges of this pin.
6	5	\overline{SYNC}	Frame synchronization input for the data input. When this pin goes low, it enables the input shift register and data is transferred on the falling edges of SCLK. The DAC is updated on the 16th clock cycle unless \overline{SYNC} is brought high before the 16th clock, in which case the rising edge of \overline{SYNC} acts as an interrupt and the write sequence is ignored by the DAC.
	2, 3	NC	No Connect. There is no internal connection to these pins.

Absolute Maximum Ratings (Notes 1, 2)

If Military/Aerospace specified devices are required, please contact the National Semiconductor Sales Office/Distributors for availability and specifications.

Supply Voltage, V_A	6.5V
Voltage on any Input Pin	-0.3V to ($V_A + 0.3V$)
Input Current at Any Pin (Note 3)	10 mA
Package Input Current (Note 3)	20 mA
Power Consumption at $T_A = 25^\circ\text{C}$	See (Note 4)
ESD Susceptibility (Note 5)	
Human Body Model	2500V
Machine Model	250V
Soldering Temperature, Infrared, 10 Seconds (Note 6)	235°C
Storage Temperature	-65°C to +150°C

Operating Ratings (Notes 1, 2)

Operating Temperature Range	
DAC101S101	$-40^\circ\text{C} \leq T_A \leq +105^\circ\text{C}$
DAC101S101Q	$-40^\circ\text{C} \leq T_A \leq +125^\circ\text{C}$
Supply Voltage, V_A	+2.7V to 5.5V
Any Input Voltage (Note 7)	-0.1 V to ($V_A + 0.1$ V)
Output Load	0 to 1500 pF
SCLK Frequency	Up to 30 MHz

Package Thermal Resistances

Package	θ_{JA}
8-Lead MSOP	240°C/W
6-Lead TSOT	250°C/W

Electrical Characteristics

The following specifications apply for $V_A = +2.7V$ to $+5.5V$, $R_L = 2k\Omega$ to GND, $C_L = 200$ pF to GND, $f_{SCLK} = 30$ MHz, input code range 12 to 1011. **Boldface limits apply for $T_{MIN} \leq T_A \leq T_{MAX}$** ; all other limits $T_A = 25^\circ\text{C}$, unless otherwise specified.

Symbol	Parameter	Conditions	Typical (Note 9)	Limits (Note 9)	Units (Limits)
STATIC PERFORMANCE					
	Resolution			10	Bits (min)
	Monotonicity			10	Bits (min)
INL	Integral Non-Linearity	Over Decimal codes 12 to 1011	± 0.6	± 2.8	LSB (max)
DNL	Differential Non-Linearity	$V_A = 2.7V$ to $5.5V$	+0.15	+0.35	LSB (max)
			-0.05	-0.2	LSB (min)
ZE	Zero Code Error	$I_{OUT} = 0$	+3.3	+15	mV (max)
FSE	Full-Scale Error	$I_{OUT} = 0$	-0.06	-1.0	%FSR (max)
GE	Gain Error	All ones Loaded to DAC register	-0.10	± 1.0	%FSR (max)
ZCED	Zero Code Error Drift		-20		$\mu\text{V}/^\circ\text{C}$
TC GE	Gain Error Tempco	$V_A = 3V$	-0.7		ppm/ $^\circ\text{C}$
		$V_A = 5V$	-1.0		ppm/ $^\circ\text{C}$
OUTPUT CHARACTERISTICS					
	Output Voltage Range	(Note 10)		0 V_A	V (min) V (max)
ZCO	Zero Code Output	$V_A = 3V, I_{OUT} = 10 \mu\text{A}$	1.8		mV
		$V_A = 3V, I_{OUT} = 100 \mu\text{A}$	5.0		mV
		$V_A = 5V, I_{OUT} = 10 \mu\text{A}$	3.7		mV
		$V_A = 5V, I_{OUT} = 100 \mu\text{A}$	5.4		mV
FSO	Full Scale Output	$V_A = 3V, I_{OUT} = 10 \mu\text{A}$	2.997		V
		$V_A = 3V, I_{OUT} = 100 \mu\text{A}$	2.990		V
		$V_A = 5V, I_{OUT} = 10 \mu\text{A}$	4.995		V
		$V_A = 5V, I_{OUT} = 100 \mu\text{A}$	4.992		V
	Maximum Load Capacitance	$R_L = \infty$	1500		pF
		$R_L = 2k\Omega$	1500		pF
	DC Output Impedance		1.3		Ohm

Symbol	Parameter	Conditions	Typical (Note 9)	Limits (Note 9)	Units (Limits)	
I_{OS}	Output Short Circuit Current	$V_A = 5V, V_{OUT} = 0V,$ Input code = 3FFh	-63		mA	
		$V_A = 3V, V_{OUT} = 0V,$ Input code = 3FFh	-50		mA	
		$V_A = 5V, V_{OUT} = 5V,$ Input code = 000h	74		mA	
		$V_A = 3V, V_{OUT} = 3V,$ Input code = 000h	53		mA	
LOGIC INPUT						
I_{IN}	Input Current (Note 10)			± 1	μA (max)	
V_{IL}	Input Low Voltage (Note 10)	$V_A = 5V$		0.8	V (max)	
		$V_A = 3V$		0.5	V (max)	
V_{IH}	Input High Voltage (Note 10)	$V_A = 5V$		2.4	V (min)	
		$V_A = 3V$		2.1	V (min)	
C_{IN}	Input Capacitance (Note 10)			3	pF (max)	
POWER REQUIREMENTS						
I_A	Supply Current (output unloaded)	Normal Mode $f_{SCLK} = 30$ MHz	$V_A = 5.5V$	256	332	μA (max)
			$V_A = 3.6V$	174	226	μA (max)
		Normal Mode $f_{SCLK} = 20$ MHz	$V_A = 5.5V$	221	297	μA (max)
			$V_A = 3.6V$	154	207	μA (max)
		Normal Mode $f_{SCLK} = 0$	$V_A = 5.5V$	145		μA (max)
			$V_A = 3.6V$	113		μA (max)
		All PD Modes, $f_{SCLK} = 30$ MHz	$V_A = 5.0V$	83		μA (max)
			$V_A = 3.0V$	42		μA (max)
		All PD Modes, $f_{SCLK} = 20$ MHz	$V_A = 5.0V$	56		μA (max)
			$V_A = 3.0V$	28		μA (max)
		All PD Modes, $f_{SCLK} = 0$ (Note 10)	$V_A = 5.5V$	0.06	1.0	μA (max)
			$V_A = 3.6V$	0.04	1.0	μA (max)
P_C	Power Consumption (output unloaded)	Normal Mode $f_{SCLK} = 30$ MHz	$V_A = 5.5V$	1.41	1.83	mW (max)
			$V_A = 3.6V$	0.63	0.81	mW (max)
		Normal Mode $f_{SCLK} = 20$ MHz	$V_A = 5.5V$	1.22	1.63	mW (max)
			$V_A = 3.6V$	0.55	0.74	mW (max)
		Normal Mode $f_{SCLK} = 0$	$V_A = 5.5V$	0.80		μW (max)
			$V_A = 3.6V$	0.41		μW (max)
		All PD Modes, $f_{SCLK} = 30$ MHz	$V_A = 5.0V$	0.42		μW (max)
			$V_A = 3.0V$	0.13		μW (max)
		All PD Modes, $f_{SCLK} = 20$ MHz	$V_A = 5.0V$	0.28		μW (max)
			$V_A = 3.0V$	0.08		μW (max)
		All PD Modes, $f_{SCLK} = 0$ (Note 10)	$V_A = 5.5V$	0.33	5.5	μW (max)
			$V_A = 3.6V$	0.14	3.6	μW (max)
I_{OUT} / I_A	Power Efficiency	$I_{LOAD} = 2mA$	$V_A = 5V$	91		%
			$V_A = 3V$	94		%

A.C. and Timing Characteristics

The following specifications apply for $V_A = +2.7V$ to $+5.5V$, $R_L = 2k\Omega$ to GND, $C_L = 200$ pF to GND, $f_{SCLK} = 30$ MHz, input code range 12 to 1011. **Boldface limits apply for $T_{MIN} \leq T_A \leq T_{MAX}$** : all other limits $T_A = 25^\circ C$, unless otherwise specified.

Symbol	Parameter	Conductions		Typical	Limits	Units (Limits)
f_{SCLK}	SCLK Frequency				30	MHz (max)
t_s	Output Voltage Settling Time (Note 10)	100h to 300h code change, $R_L = 2k\Omega$	$C_L \leq 200$ pF	5	7.5	μs (max)
SR	Output Slew Rate			1		V/ μs
	Glitch Impulse	Code change from 200h to 1FFh		12		nV-sec
	Digital Feedthrough			0.5		nV-sec
t_{WU}	Wake-Up Time	$V_A = 5V$		1.6		μs
		$V_A = 3V$		1.9		μs
$1/f_{SCLK}$	SCLK Cycle Time				33	ns (min)
t_H	SCLK High time			5	13	ns (min)
t_L	SCLK Low Time			5	13	ns (min)
t_{SACL}	Set-up Time \overline{SYNC} to SCLK Rising Edge			-15	0	ns (min)
t_{SUD}	Data Set-Up Time			2.5	5	ns (min)
t_{DHD}	Data Hold Time			2.5	4.5	ns (min)
t_{CS}	SCLK fall to rise of \overline{SYNC}	$V_A = 5V$		0	3	ns (min)
		$V_A = 3V$		-2	1	ns (min)
t_{SYNC}	\overline{SYNC} High Time	$2.7 \leq V_A \leq 3.6$		9	20	ns (min)
		$3.6 \leq V_A \leq 5.5$		5	10	ns (min)

Note 1: Absolute Maximum Ratings indicate limits beyond which damage to the device may occur. Operating Ratings indicate conditions for which the device is functional, but do not guarantee specific performance limits. For guaranteed specifications and test conditions, see the Electrical Characteristics. The guaranteed specifications apply only for the test conditions listed. Some performance characteristics may degrade when the device is not operated under the listed test conditions.

Note 2: All voltages are measured with respect to GND = 0V, unless otherwise specified

Note 3: When the input voltage at any pin exceeds the power supplies (that is, less than GND, or greater than V_A), the current at that pin should be limited to 10 mA. The 20 mA maximum package input current rating limits the number of pins that can safely exceed the power supplies with an input current of 10 mA to two.

Note 4: The absolute maximum junction temperature (T_{jmax}) for this device is $150^\circ C$. The maximum allowable power dissipation is dictated by T_{jmax} , the junction-to-ambient thermal resistance (θ_{JA}), and the ambient temperature (T_A), and can be calculated using the formula $P_{DMAX} = (T_{jmax} - T_A) / \theta_{JA}$. The values for maximum power dissipation will be reached only when the device is operated in a severe fault condition (e.g., when input or output pins are driven beyond the power supply voltages, or the power supply polarity is reversed). Obviously, such conditions should always be avoided.

Note 5: Human body model is 100 pF capacitor discharged through a 1.5 k Ω resistor. Machine model is 220 pF discharged through ZERO Ohms.

Note 6: See the section entitled "Surface Mount" found in any post 1986 National Semiconductor Linear Data Book for methods of soldering surface mount devices.

Note 7: The analog inputs are protected as shown below. Input voltage magnitudes up to $V_A + 300$ mV or to 300 mV below GND will not damage this device. However, errors in the conversion result can occur if any input goes above V_A or below GND by more than 100 mV. For example, if V_A is $2.7V_{DC}$, ensure that $-100mV \leq$ input voltages $\leq 2.8V_{DC}$ to ensure accurate conversions.

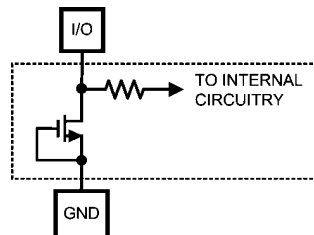

20154104

Note 8: To guarantee accuracy, it is required that V_A be well bypassed.

Note 9: Typical figures are at $T_j = 25^\circ C$, and represent most likely parametric norms. Test limits are guaranteed to National's AOQL (Average Outgoing Quality Level).

Note 10: This parameter is guaranteed by design and/or characterization and is not tested in production.

Specification Definitions

DIFFERENTIAL NON-LINEARITY (DNL) is the measure of the maximum deviation from the ideal step size of 1 LSB, which is $V_{REF} / 1024 = V_A / 1024$.

DIGITAL FEEDTHROUGH is a measure of the energy injected into the analog output of the DAC from the digital inputs when the DAC outputs are not updated. It is measured with a full-scale code change on the data bus.

FULL-SCALE ERROR is the difference between the actual output voltage with a full scale code (3FFh) loaded into the DAC and the value of $V_A \times 1023 / 1024$.

GAIN ERROR is the deviation from the ideal slope of the transfer function. It can be calculated from Zero and Full-Scale Errors as $GE = FSE - ZE$, where GE is Gain error, FSE is Full-Scale Error and ZE is Zero Error.

GLITCH IMPULSE is the energy injected into the analog output when the input code to the DAC register changes. It is specified as the area of the glitch in nanovolt-seconds.

INTEGRAL NON-LINEARITY (INL) is a measure of the deviation of each individual code from a straight line through the input to output transfer function. The deviation of any given code from this straight line is measured from the center of that code value. The end point method is used. INL for this product is specified over a limited range, per the Electrical Tables.

LEAST SIGNIFICANT BIT (LSB) is the bit that has the smallest value or weight of all bits in a word. This value is

$$LSB = V_{REF} / 2^n$$

where V_{REF} is the supply voltage for this product, and "n" is the DAC resolution in bits, which is 10 for the DAC101S101.

MAXIMUM LOAD CAPACITANCE is the maximum capacitance that can be driven by the DAC with output stability maintained.

MONOTONICITY is the condition of being monotonic, where the DAC has an output that never decreases when the output code increases.

MOST SIGNIFICANT BIT (MSB) is the bit that has the largest value or weight of all bits in a word. Its value is 1/2 of V_{REF} .

POWER EFFICIENCY is the ratio of the output current to the total supply current. The output current comes from the power supply. The difference between the supply and output currents, is the power consumed by the device without a load.

SETTLING TIME is the time for the output to settle within 1/2 LSB of the final value.

WAKE-UP TIME is the time for the output to settle within 1/2 LSB of the final value after the device is commanded to the active mode from any of the power down modes.

ZERO CODE ERROR is the output error, or voltage, present at the DAC output after a code of 000h has been entered.

Transfer Characteristic

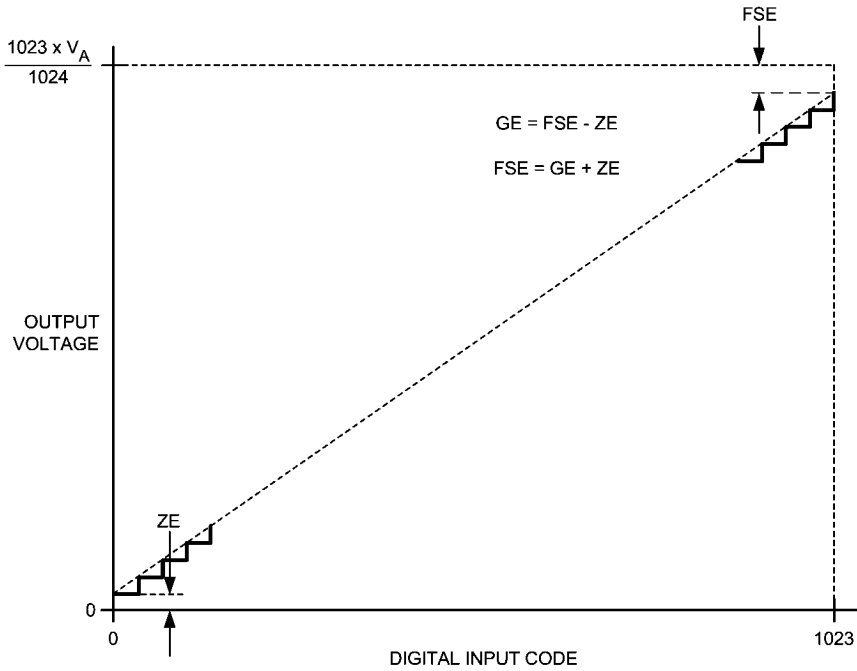

FIGURE 1. Input / Output Transfer Characteristic

Timing Diagram

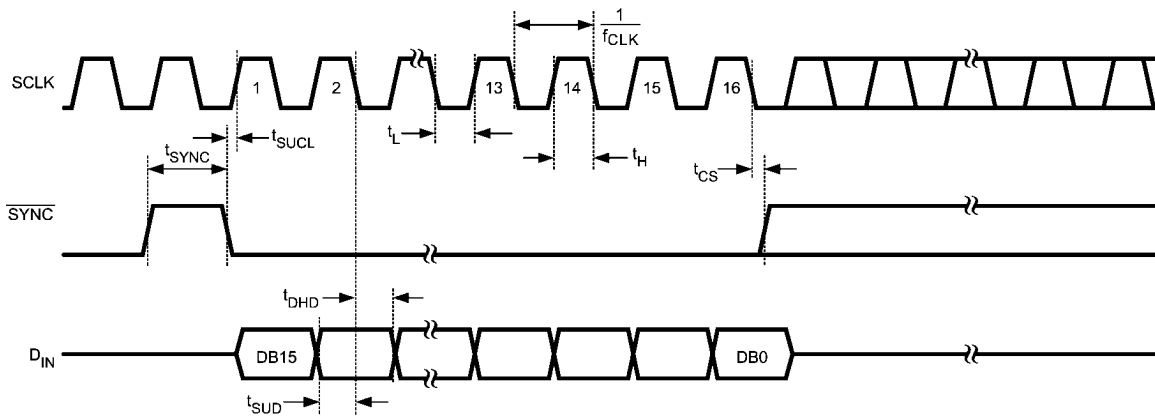
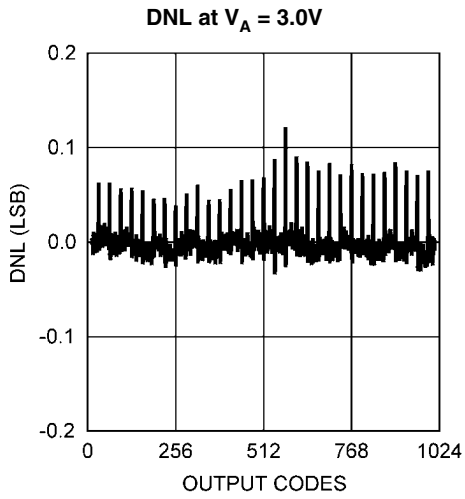

FIGURE 2. DAC101S101 Timing

Typical Performance Characteristics
 otherwise stated

$f_{SCLK} = 30 \text{ MHz}$, $T_A = 25\text{C}$, Input Code Range 12 to 1011, unless



20154152

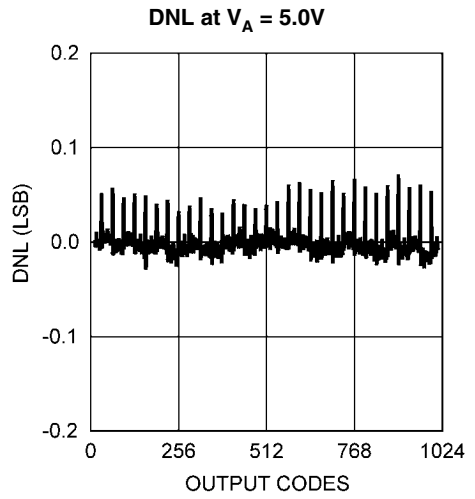

20154153

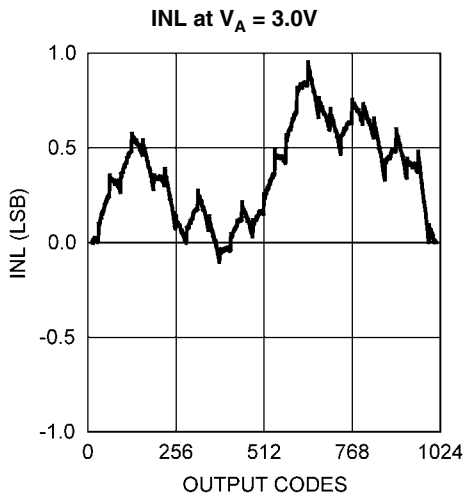

20154154

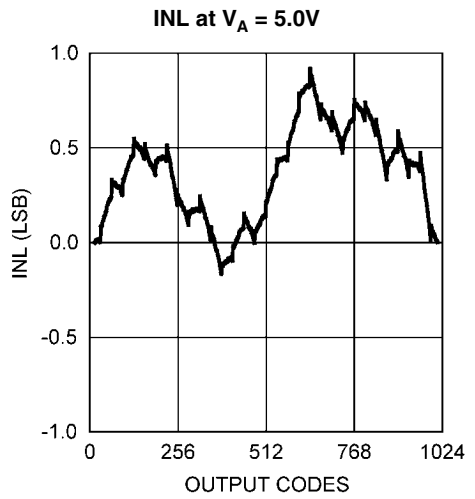

20154155

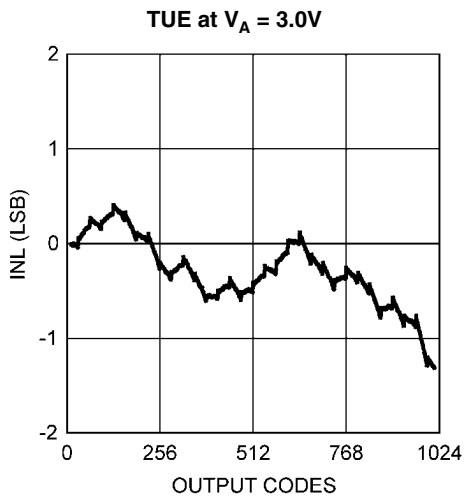

20154156

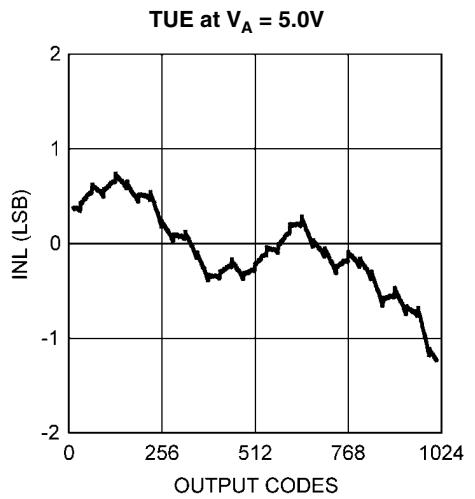

20154157

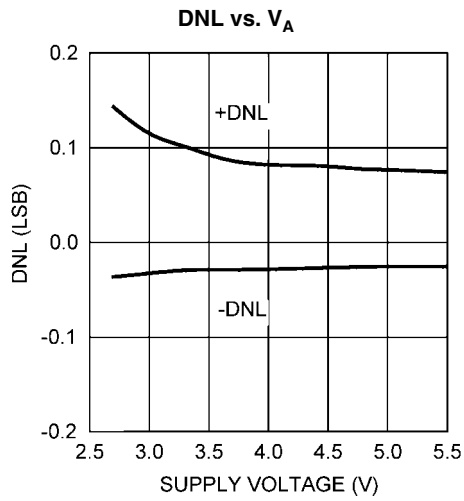

20154122

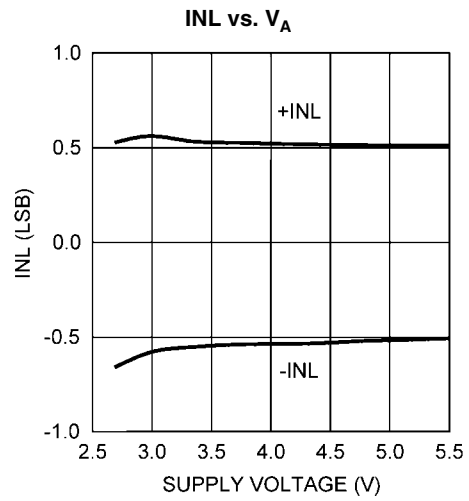

20154123

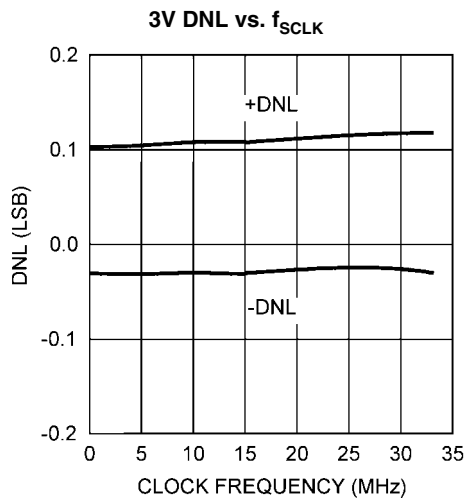

20154150

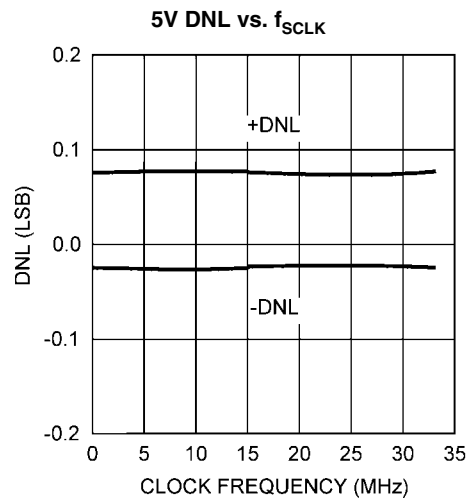

20154151

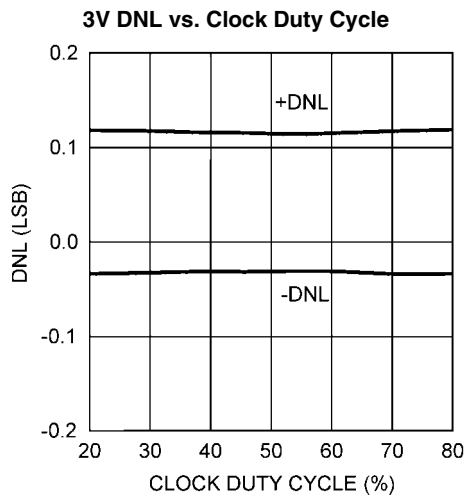

20154124

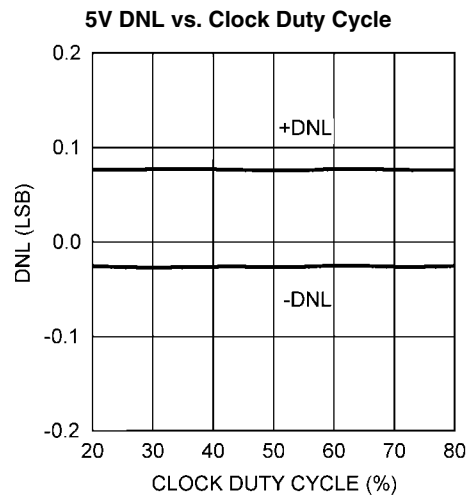

20154125

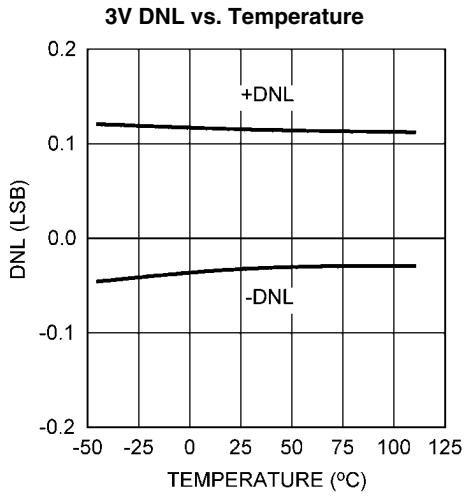

20154126

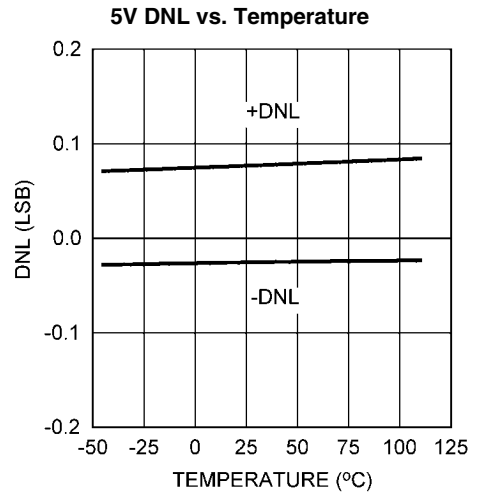

20154127

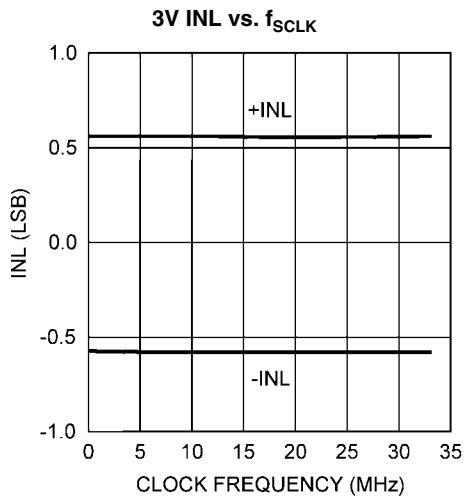

20154128

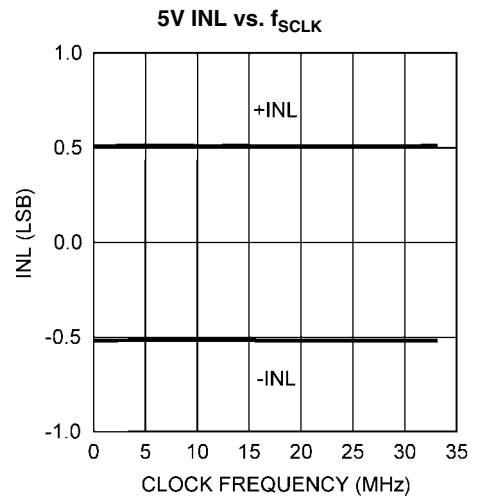

20154129

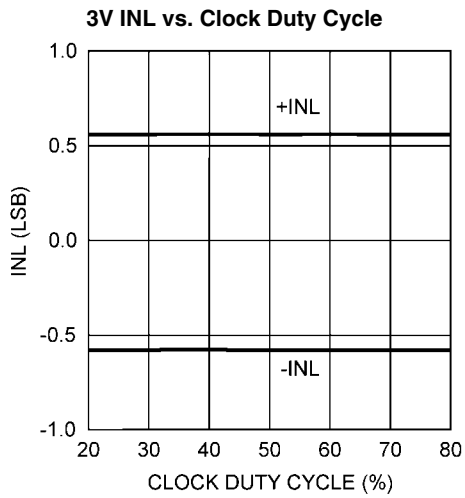

20154130

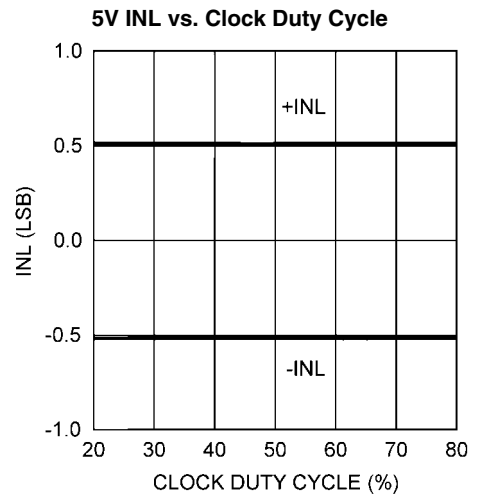

20154131

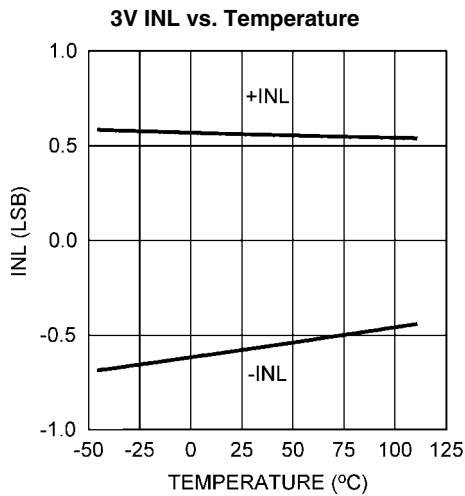

20154132

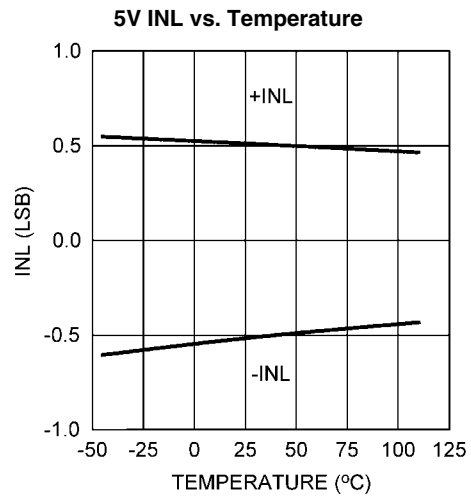

20154133

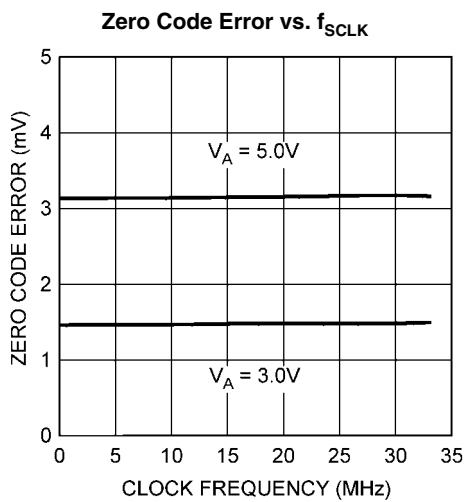

20154134

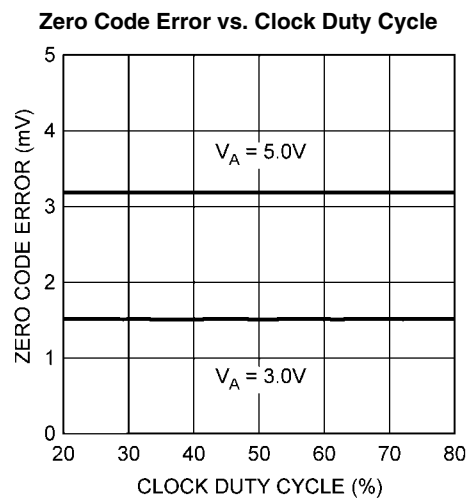

20154135

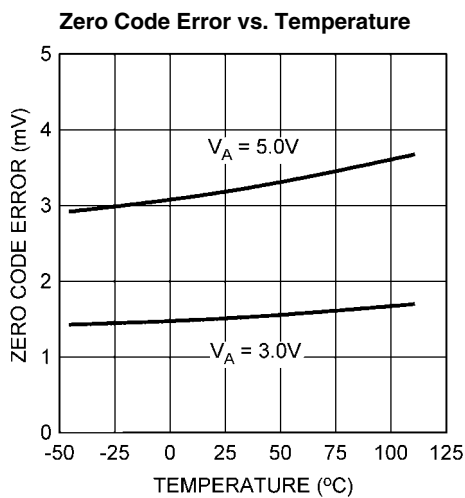

20154136

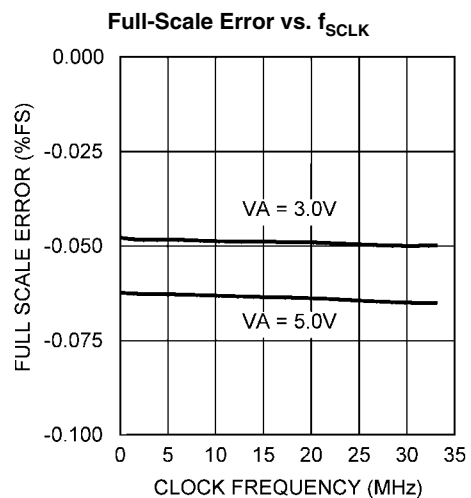

20154137

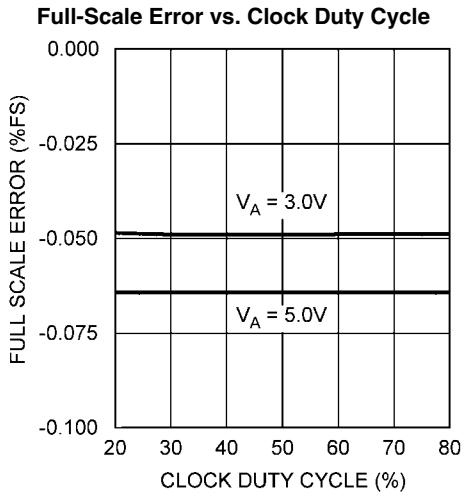

20154138

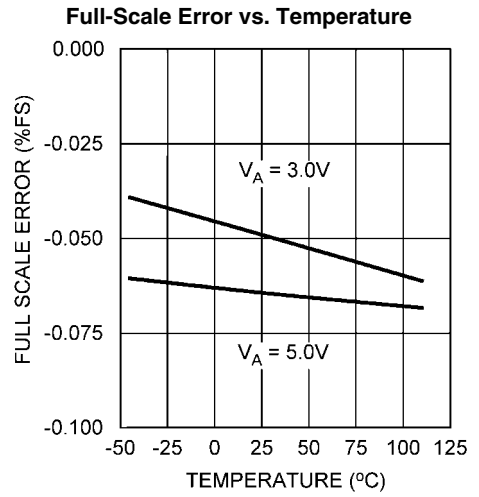

20154139

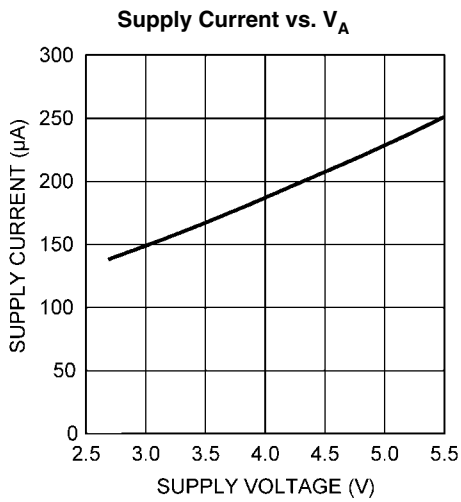

20154144

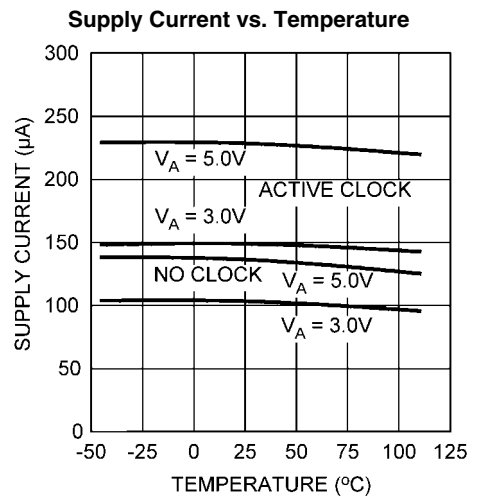

20154145

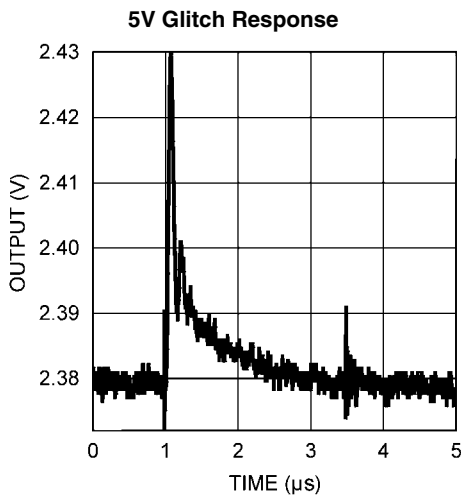

20154146

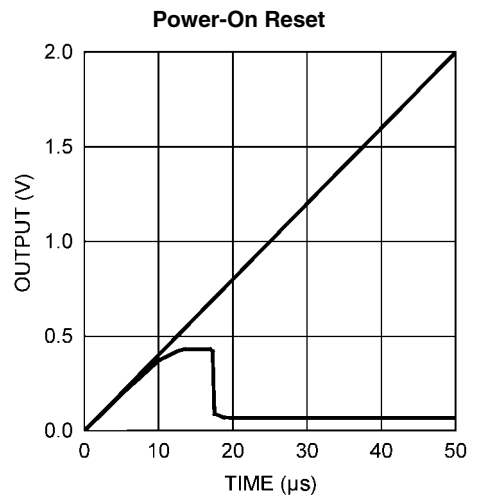

20154147

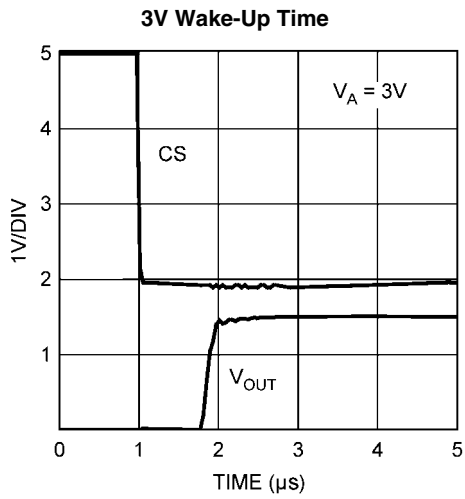

20154148

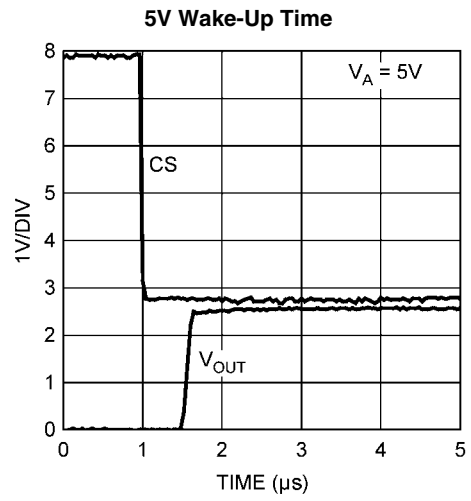

20154149

1.0 Functional Description

1.1 DAC SECTION

The DAC101S101 is fabricated on a CMOS process with an architecture that consists of a resistor string and switches that are followed by an output buffer. The power supply serves as the reference voltage. The input coding is straight binary with an ideal output voltage of:

$$V_{OUT} = V_A \times (D / 1024)$$

where *D* is the decimal equivalent of the binary code that is loaded into the DAC register and can take on any value between 0 and 1023.

1.2 RESISTOR STRING

The resistor string is shown in *Figure 3*. This string consists of 1024 equal valued resistors in series with a switch at each junction of two resistors, plus a switch to ground. The code loaded into the DAC register determines which switch is closed, connecting the proper node to the amplifier. This configuration guarantees that the DAC is monotonic.

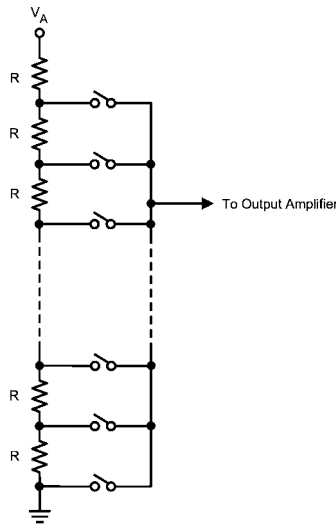

20154107

FIGURE 3. DAC Resistor String

1.3 OUTPUT AMPLIFIER

The output buffer amplifier is a rail-to-rail type, providing an output voltage range of 0V to *V_A*. All amplifiers, even rail-to-rail types, exhibit a loss of linearity as the output approaches the supply rails (0V and *V_A*, in this case). For this reason, linearity is specified over less than the full output range of the DAC. The output capabilities of the amplifier are described in the Electrical Tables.

1.4 SERIAL INTERFACE

The three-wire interface is compatible with SPI, QSPI and MICROWIRE as well as most DSPs. See the Timing Diagram for information on a write sequence.

A write sequence begins by bringing the *SYNC* line low. Once *SYNC* is low, the data on the *D_{IN}* line is clocked into the 16-bit serial input register on the falling edges of *SCLK*. On the 16th falling clock edge, the last data bit is clocked in and the programmed function (a change in the mode of operation and/or a change in the DAC register contents) is executed. At this

point the *SYNC* line may be kept low or brought high. In either case, it must be brought high for the minimum specified time before the next write sequence so that a falling edge of *SYNC* can initiate the next write cycle.

Since the *SYNC* and *D_{IN}* buffers draw more current when they are high, they should be idled low between write sequences to minimize power consumption.

1.5 INPUT SHIFT REGISTER

The input shift register, *Figure 4*, has sixteen bits. The first two bits are "don't cares" and are followed by two bits that determine the mode of operation (normal mode or one of three power-down modes). The contents of the serial input register are transferred to the DAC register on the sixteenth falling edge of *SCLK*. See Timing Diagram, *Figure 2*.

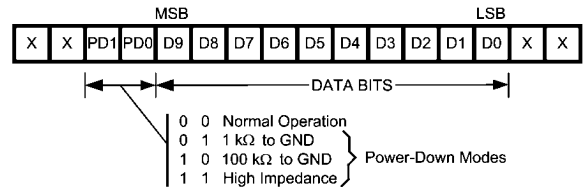

20154108

FIGURE 4. Input Register Contents

Normally, the *SYNC* line is kept low for at least 16 falling edges of *SCLK* and the DAC is updated on the 16th *SCLK* falling edge. However, if *SYNC* is brought high before the 16th falling edge, the shift register is reset and the write sequence is invalid. The DAC register is not updated and there is no change in the mode of operation.

1.6 POWER-ON RESET

The power-on reset circuit controls the output voltage during power-up. The DAC register is filled with zeros and the output voltage is 0 Volts and remains there until a valid write sequence is made to the DAC.

1.7 POWER-DOWN MODES

The DAC101S101 has four modes of operation. These modes are set with two bits (DB13 and DB12) in the control register.

TABLE 1. Modes of Operation

DB13	DB12	Operating Mode
0	0	Normal Operation
0	1	Power-Down with 1kΩ to GND
1	0	Power-Down with 100kΩ to GND
1	1	Power-Down with Hi-Z

When both DB13 and DB12 are 0, the device operates normally. For the other three possible combinations of these bits the supply current drops to its power-down level and the output is pulled down with either a 1kΩ or a 100KΩ resistor, or is in a high impedance state, as described in *Table 1*.

The bias generator, output amplifier, the resistor string and other linear circuitry are all shut down in any of the power-down modes. However, the contents of the DAC register are unaffected when in power-down. Minimum power consumption is achieved in the power-down mode with *SCLK* disabled and *SYNC* and *D_{IN}* idled low.

2.0 Applications Information

The simplicity of the DAC101S101 implies ease of use. However, it is important to recognize that any data converter that utilizes its supply voltage as its reference voltage will have essentially zero PSRR (Power Supply Rejection Ratio). Therefore, it is necessary to provide a noise-free supply voltage to the device.

2.1 DSP/MICROPROCESSOR INTERFACING

Interfacing the DAC101S101 to microprocessors and DSPs is quite simple. The following guidelines are offered to hasten the design process.

2.1.1 ADSP-2101/ADSP2103 Interfacing

Figure 5 shows a serial interface between the DAC101S101 and the ADSP-2101/ADSP2103. The DSP should be set to operate in the SPORT Transmit Alternate Framing Mode. It is programmed through the SPORT control register and should be configured for Internal Clock Operation, Active Low Framing and 16-bit Word Length. Transmission is started by writing a word to the Tx register after the SPORT mode has been enabled.

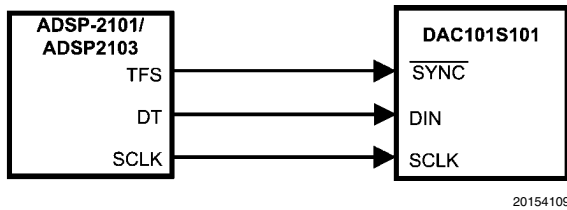

FIGURE 5. ADSP-2101/2103 Interface

2.1.2 80C51/80L51 Interface

A serial interface between the DAC101S101 and the 80C51/80L51 microcontroller is shown in Figure 6. The SYNC signal comes from a bit-programmable pin on the microcontroller. The example shown here uses port line P3.3. This line is taken low when data is to be transmitted to the DAC101S101. Since the 80C51/80L51 transmits 8-bit bytes, only eight falling clock edges occur in the transmit cycle. To load data into the DAC, the P3.3 line must be left low after the first eight bits are transmitted. A second write cycle is initiated to transmit the second byte of data, after which port line P3.3 is brought high. The 80C51/80L51 transmit routine must recognize that the 80C51/80L51 transmits data with the LSB first while the DAC101S101 requires data with the MSB first.

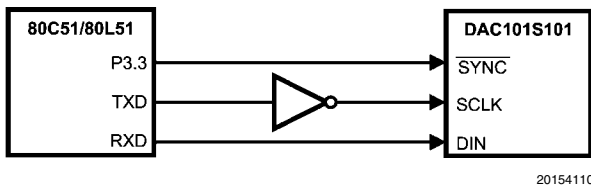

FIGURE 6. 80C51/80L51 Interface

2.1.3 68HC11 Interface

A serial interface between the DAC101S101 and the 68HC11 microcontroller is shown in Figure 7. The SYNC line of the DAC101S101 is driven from a port line (PC7 in the figure), similar to the 80C51/80L51.

The 68HC11 should be configured with its CPOL bit as a zero and its CPHA bit as a one. This configuration causes data on

the MOSI output to be valid on the falling edge of SCLK. PC7 is taken low to transmit data to the DAC. The 68HC11 transmits data in 8-bit bytes with eight falling clock edges. Data is transmitted with the MSB first. PC7 must remain low after the first eight bits are transferred. A second write cycle is initiated to transmit the second byte of data to the DAC, after which PC7 should be raised to end the write sequence.

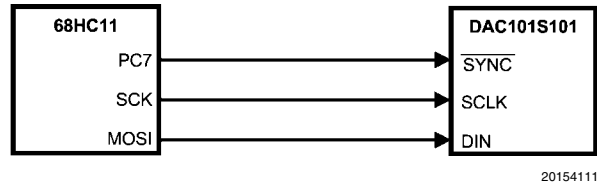

FIGURE 7. 68HC11 Interface

2.1.4 Microwire Interface

Figure 8 shows an interface between a Microwire compatible device and the DAC101S101. Data is clocked out on the rising edges of the SCLK signal.

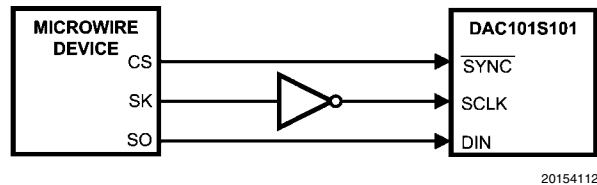

FIGURE 8. Microwire Interface

2.2 USING REFERENCES AS POWER SUPPLIES

Recall the need for a quiet supply source for devices that use their power supply voltage as a reference voltage.

Since the DAC101S101 consumes very little power, a reference source may be used as the supply voltage. The advantages of using a reference source over a voltage regulator are accuracy and stability. Some low noise regulators can also be used for the power supply of the DAC101S101. Listed below are a few power supply options for the DAC101S101.

2.2.1 LM4130

The LM4130 reference, with its 0.05% accuracy over temperature, is a good choice as a power source for the DAC101S101. Its primary disadvantage is the lack of a 3V and 5V versions. However, the 4.096V version is useful if a 0 to 4.095V output range is desirable or acceptable. Bypassing the VIN pin with a 0.1µF capacitor and the VOUT pin with a 2.2µF capacitor will improve stability and reduce output noise. The LM4130 comes in a space-saving 5-pin SOT23.

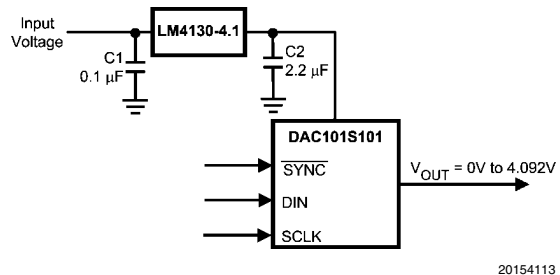

FIGURE 9. The LM4130 as a power supply

2.2.2 LM4050

Available with accuracy of 0.44%, the LM4050 shunt reference is also a good choice as a power regulator for the DAC101S101. It does not come in a 3 Volt version, but 4.096V and 5V versions are available. It comes in a space-saving 3-pin SOT23.

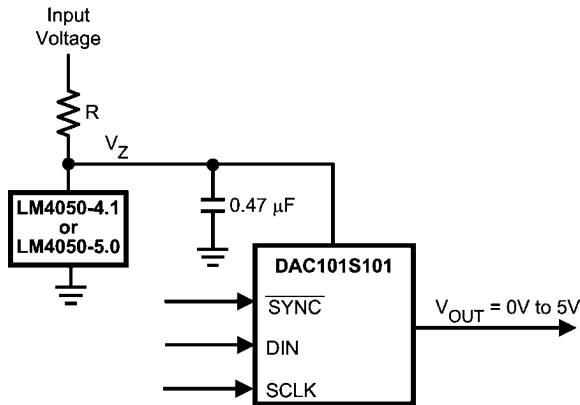

FIGURE 10. The LM4050 as a power supply

The minimum resistor value in the circuit of *Figure 10* should be chosen such that the maximum current through the LM4050 does not exceed its 15 mA rating. The conditions for maximum current include the input voltage at its maximum, the LM4050 voltage at its minimum, the resistor value at its minimum due to tolerance, and the DAC101S101 draws zero current. The maximum resistor value must allow the LM4050 to draw more than its minimum current for regulation plus the maximum DAC101S101 current in full operation. The conditions for minimum current include the input voltage at its minimum, the LM4050 voltage at its maximum, the resistor value at its maximum due to tolerance, and the DAC101S101 draws its maximum current. These conditions can be summarized as

$$R(\min) = (V_{IN}(\max) - V_Z(\min) / (I_A(\min) + I_Z(\max)))$$

and

$$R(\max) = (V_{IN}(\min) - V_Z(\max) / (I_A(\max) + I_Z(\min)))$$

where $V_Z(\min)$ and $V_Z(\max)$ are the nominal LM4050 output voltages \pm the LM4050 output tolerance over temperature, $I_Z(\max)$ is the maximum allowable current through the LM4050, $I_Z(\min)$ is the minimum current required by the LM4050 for proper regulation, $I_A(\max)$ is the maximum DAC101S101 supply current, and $I_A(\min)$ is the minimum DAC101S101 supply current.

2.2.3 LP3985

The LP3985 is a low noise, ultra low dropout voltage regulator with a 3% accuracy over temperature. It is a good choice for applications that do not require a precision reference for the DAC101S101. It comes in 3.0V, 3.3V and 5V versions, among

others, and sports a low 30 μ V noise specification at low frequencies. Since low frequency noise is relatively difficult to filter, this specification could be important for some applications. The LP3985 comes in a space-saving 5-pin SOT23 and 5-bump micro SMD packages.

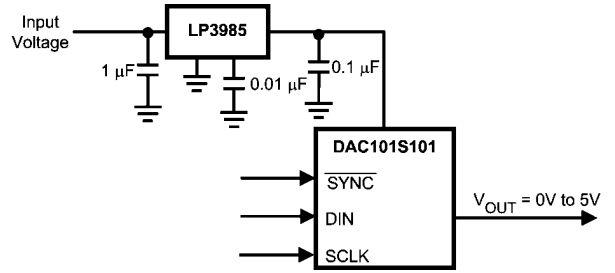

FIGURE 11. Using the LP3985 regulator

An input capacitance of 1.0 μ F without any ESR requirement is required at the LP3985 input, while a 1.0 μ F ceramic capacitor with an ESR requirement of 5m Ω to 500m Ω is required at the output. Careful interpretation and understanding of the capacitor specification is required to ensure correct device operation.

2.2.4 LP2980

The LP2980 is an ultra low dropout regulator with a 0.5% or 1.0% accuracy over temperature, depending upon grade. It is available in 3.0V, 3.3V and 5V versions, among others.

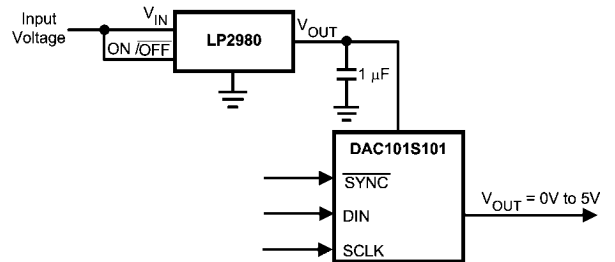
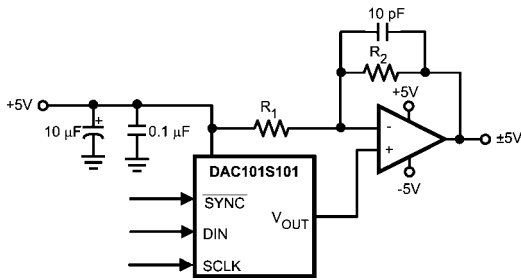

FIGURE 12. Using the LP2980 regulator

Like any low dropout regulator, the LP2980 requires an output capacitor for loop stability. This output capacitor must be at least 1.0 μ F over temperature, but values of 2.2 μ F or more will provide even better performance. The ESR of this capacitor should be within the range specified in the LP2980 data sheet. Surface-mount solid tantalum capacitors offer a good combination of small size and ESR. Ceramic capacitors are attractive due to their small size but generally have ESR values that are too low for use with the LP2980. Aluminum electrolytic capacitors are typically not a good choice due to their large size and have ESR values that may be too high at low temperatures.

2.3 BIPOLAR OPERATION

The DAC101S101 is designed for single supply operation and thus has a unipolar output. However, a bipolar output may be obtained with the circuit in *Figure 13*. This circuit will provide an output voltage range of ± 5 Volts. A rail-to-rail amplifier should be used if the amplifier supplies are limited to $\pm 5V$.



20154117

FIGURE 13. Bipolar Operation

The output voltage of this circuit for any code is found to be

$$V_O = (V_A \times (D / 1024) \times ((R1 + R2) / R1) - V_A \times R2 / R1)$$

where D is the input code in decimal form. With $V_A = 5V$ and $R1 = R2$,

$$V_O = (10 \times D / 1024) - 5V$$

A list of rail-to-rail amplifiers suitable for this application are indicated in *Table 2*.

TABLE 2. Some Rail-to-Rail Amplifiers

AMP	PKGS	Typ V_{OS}	Typ I_{SUPPLY}
LMC7111	DIP-8 SOT23-5	0.9 mV	25 μA
LM7301	SO-8 SOT23-5	0.03 mV	620 μA
LM8261	SOT23-5	0.7 mV	1 mA

2.4 LAYOUT, GROUNDING, AND BYPASSING

For best accuracy and minimum noise, the printed circuit board containing the DAC101S101 should have separate analog and digital areas. The areas are defined by the locations of the analog and digital power planes. Both of these planes should be located in the same board layer. There should be a single ground plane. A single ground plane is preferred if digital return current does not flow through the analog ground area. Frequently a single ground plane design will utilize a "fencing" technique to prevent the mixing of analog and digital ground current. Separate ground planes should only be utilized when the fencing technique is inadequate. The separate ground planes must be connected in one place, preferably near the DAC101S101. Special care is required to guarantee that digital signals with fast edge rates do not pass over split ground planes. They must always have a continuous return path below their traces.

The DAC101S101 power supply should be bypassed with a 10 μF and a 0.1 μF capacitor as close as possible to the device with the 0.1 μF right at the device supply pin. The 10 μF capacitor should be a tantalum type and the 0.1 μF capacitor should be a low ESL, low ESR type. The power supply for the DAC101S101 should only be used for analog circuits.

Avoid crossover of analog and digital signals and keep the clock and data lines on the component side of the board. The clock and data lines should have controlled impedances.

Physical Dimensions inches (millimeters) unless otherwise noted

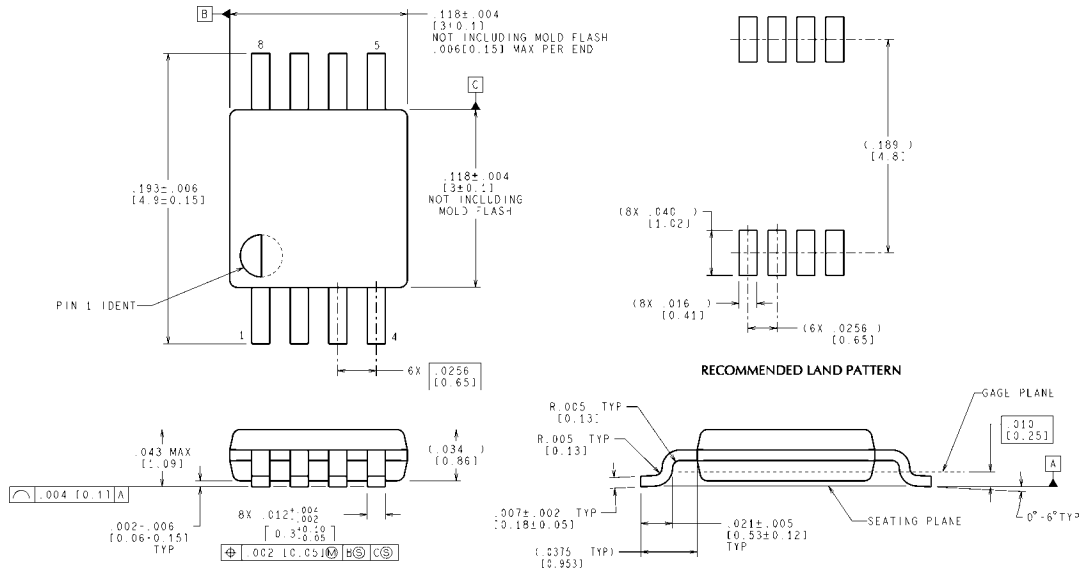

8-Lead MSOP
Order Number DAC101S101CIMM
NS Package Number MUA08A

MUA08A (Rev F)

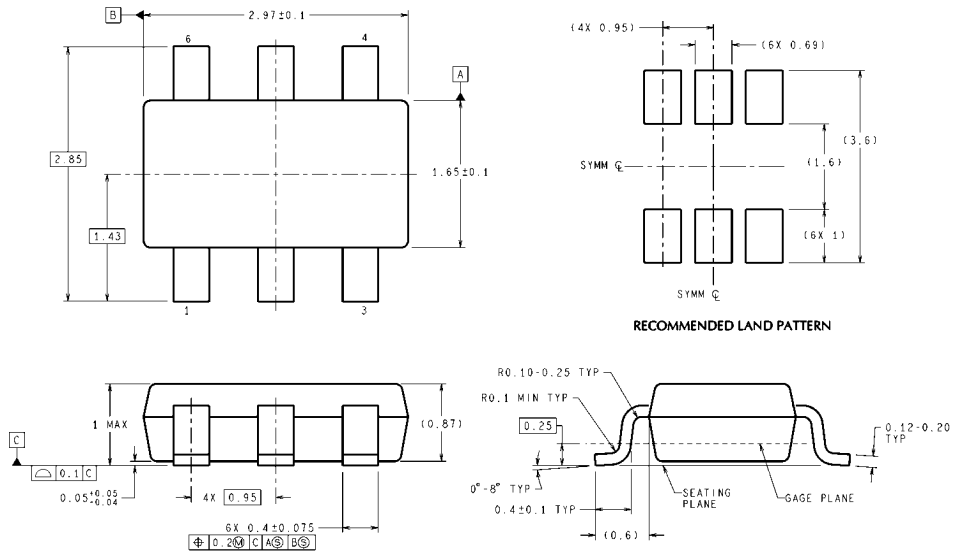

6-Lead TSOT
Order Numbers DAC101S101CIMK and DAC101S101QCMK
NS Package Number MK06A

MK06A (Rev D)

Notes

DAC101S101

Notes

For more National Semiconductor product information and proven design tools, visit the following Web sites at:

Products		Design Support	
Amplifiers	www.national.com/amplifiers	WEBENCH	www.national.com/webench
Audio	www.national.com/audio	Analog University	www.national.com/AU
Clock Conditioners	www.national.com/timing	App Notes	www.national.com/appnotes
Data Converters	www.national.com/adc	Distributors	www.national.com/contacts
Displays	www.national.com/displays	Green Compliance	www.national.com/quality/green
Ethernet	www.national.com/ethernet	Packaging	www.national.com/packaging
Interface	www.national.com/interface	Quality and Reliability	www.national.com/quality
LVDS	www.national.com/lvds	Reference Designs	www.national.com/refdesigns
Power Management	www.national.com/power	Feedback	www.national.com/feedback
Switching Regulators	www.national.com/switchers		
LDOs	www.national.com/lido		
LED Lighting	www.national.com/led		
PowerWise	www.national.com/powerwise		
Serial Digital Interface (SDI)	www.national.com/sdi		
Temperature Sensors	www.national.com/tempsensors		
Wireless (PLL/VCO)	www.national.com/wireless		

THE CONTENTS OF THIS DOCUMENT ARE PROVIDED IN CONNECTION WITH NATIONAL SEMICONDUCTOR CORPORATION ("NATIONAL") PRODUCTS. NATIONAL MAKES NO REPRESENTATIONS OR WARRANTIES WITH RESPECT TO THE ACCURACY OR COMPLETENESS OF THE CONTENTS OF THIS PUBLICATION AND RESERVES THE RIGHT TO MAKE CHANGES TO SPECIFICATIONS AND PRODUCT DESCRIPTIONS AT ANY TIME WITHOUT NOTICE. NO LICENSE, WHETHER EXPRESS, IMPLIED, ARISING BY ESTOPPEL OR OTHERWISE, TO ANY INTELLECTUAL PROPERTY RIGHTS IS GRANTED BY THIS DOCUMENT.

TESTING AND OTHER QUALITY CONTROLS ARE USED TO THE EXTENT NATIONAL DEEMS NECESSARY TO SUPPORT NATIONAL'S PRODUCT WARRANTY. EXCEPT WHERE MANDATED BY GOVERNMENT REQUIREMENTS, TESTING OF ALL PARAMETERS OF EACH PRODUCT IS NOT NECESSARILY PERFORMED. NATIONAL ASSUMES NO LIABILITY FOR APPLICATIONS ASSISTANCE OR BUYER PRODUCT DESIGN. BUYERS ARE RESPONSIBLE FOR THEIR PRODUCTS AND APPLICATIONS USING NATIONAL COMPONENTS. PRIOR TO USING OR DISTRIBUTING ANY PRODUCTS THAT INCLUDE NATIONAL COMPONENTS, BUYERS SHOULD PROVIDE ADEQUATE DESIGN, TESTING AND OPERATING SAFEGUARDS.

EXCEPT AS PROVIDED IN NATIONAL'S TERMS AND CONDITIONS OF SALE FOR SUCH PRODUCTS, NATIONAL ASSUMES NO LIABILITY WHATSOEVER, AND NATIONAL DISCLAIMS ANY EXPRESS OR IMPLIED WARRANTY RELATING TO THE SALE AND/OR USE OF NATIONAL PRODUCTS INCLUDING LIABILITY OR WARRANTIES RELATING TO FITNESS FOR A PARTICULAR PURPOSE, MERCHANTABILITY, OR INFRINGEMENT OF ANY PATENT, COPYRIGHT OR OTHER INTELLECTUAL PROPERTY RIGHT.

LIFE SUPPORT POLICY

NATIONAL'S PRODUCTS ARE NOT AUTHORIZED FOR USE AS CRITICAL COMPONENTS IN LIFE SUPPORT DEVICES OR SYSTEMS WITHOUT THE EXPRESS PRIOR WRITTEN APPROVAL OF THE CHIEF EXECUTIVE OFFICER AND GENERAL COUNSEL OF NATIONAL SEMICONDUCTOR CORPORATION. As used herein:

Life support devices or systems are devices which (a) are intended for surgical implant into the body, or (b) support or sustain life and whose failure to perform when properly used in accordance with instructions for use provided in the labeling can be reasonably expected to result in a significant injury to the user. A critical component is any component in a life support device or system whose failure to perform can be reasonably expected to cause the failure of the life support device or system or to affect its safety or effectiveness.

National Semiconductor and the National Semiconductor logo are registered trademarks of National Semiconductor Corporation. All other brand or product names may be trademarks or registered trademarks of their respective holders.

Copyright© 2008 National Semiconductor Corporation

For the most current product information visit us at www.national.com



National Semiconductor Americas Technical Support Center
 Email: support@nsc.com
 Tel: 1-800-272-9959

National Semiconductor Europe Technical Support Center
 Email: europe.support@nsc.com
 German Tel: +49 (0) 180 5010 771
 English Tel: +44 (0) 870 850 4288

National Semiconductor Asia Pacific Technical Support Center
 Email: ap.support@nsc.com

National Semiconductor Japan Technical Support Center
 Email: jpn.feedback@nsc.com